

# Manual of proper gluing and set-up of containers in game box for BARRAGE

Crowd out gently elements from the tail – it is recommended to use a paper knife to cut connection points.

Prepare only elements that must be linked together.

Do not cut out all the pieces at the same time as you may stir them and make a mistake.

Some elements are designed in such a way that it is impossible to glue them wrongly.

If you have some problems, try to rotate the element – it should help. Be attentive – some pieces differ slightly from each other.

It is recommended to use wood glue.

If you have some doubts or you need help, please contact us by e-mail or our Facebook profile – reDrewno.

Different kinds of containers are marked by letters and numbers.

The order of gluing was shown by lines from left to right and from top to bottom.

After gluing, leave the insert for a minimum of 24 hours until fully dry. Then arrange the elements according to the engravings on the containers and the instructions.

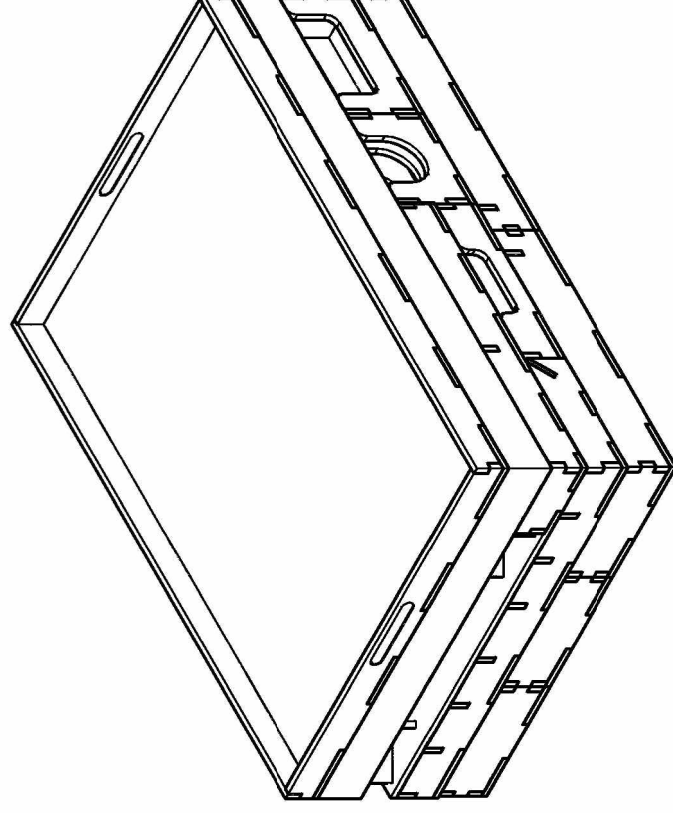

Thank you for buying of our insert.  
We wish you only successful games!  
reDrewno.pl Shop Team  
sklep@redrewno.pl

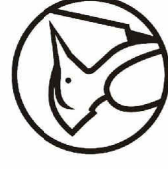

reDrewno

# Manual set-up of containers in game box for BARRAGE

Container for Hydroelectric credits

5x Containers for Company

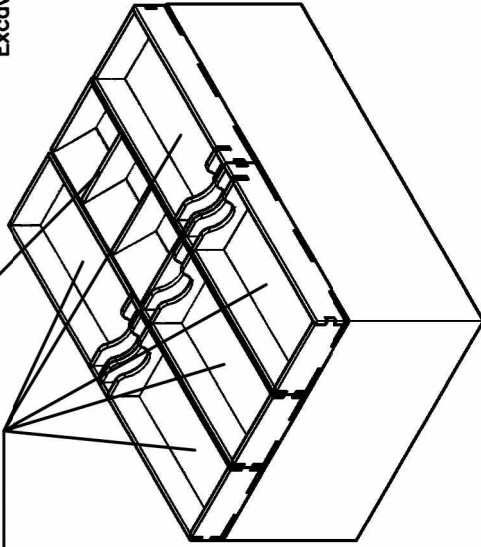

Container for Contract Tiles and Advanced Technology Tiles

Container for Automa Tiles and Player Aids

Container Concrete Mixers, Excavators, Water Drops

Container for tiles: Headstream, Starting Setup, Private Contract and Executive Officers

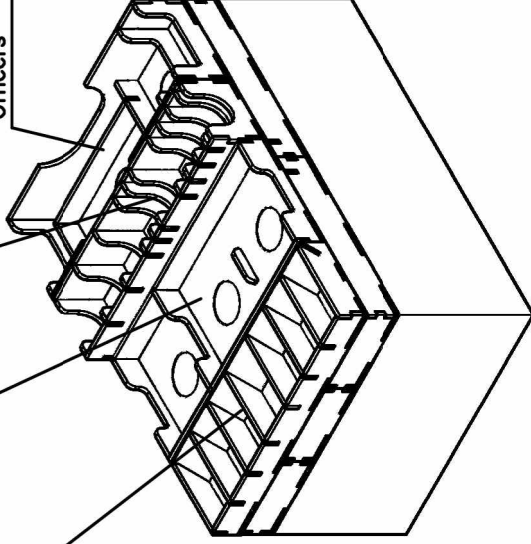

Tray for Objective tiles, Bonus tiles, Neutral Elevations, Neutral Bases and Construction Wheels

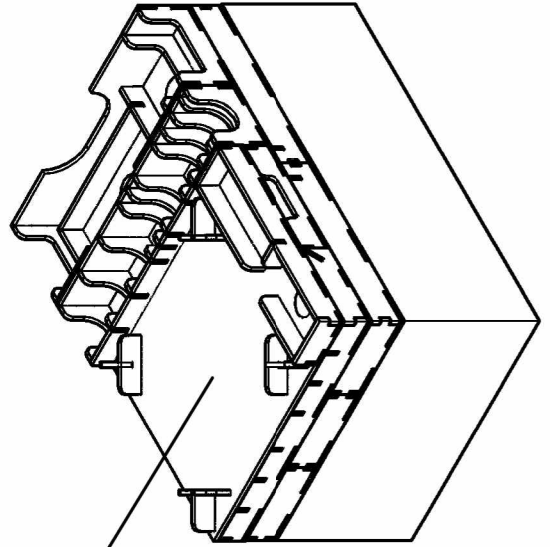

Place the Pressure Tray on top. Depending on the accessories you have, put the smaller boards into it so that the tray does not stick out of the box

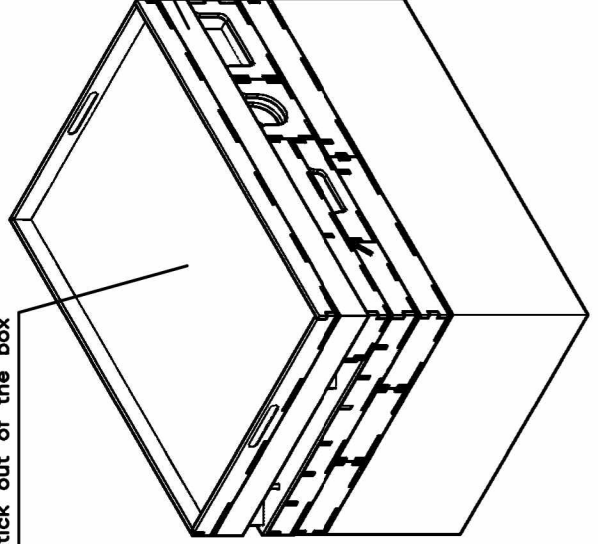

Place the Management Board, Company Boards, Rulebooks under the Tray and the boards that were left after placing the elements in the containers

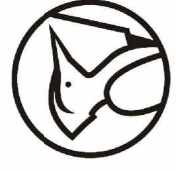

reDrewno

# Manual of proper gluing of containers – BARRAGE

5x Containers for Company

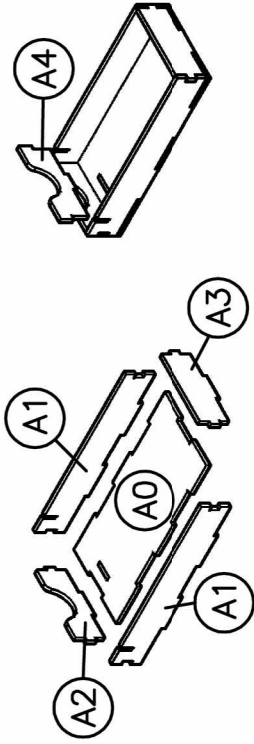

Container for Hydroelectric credits

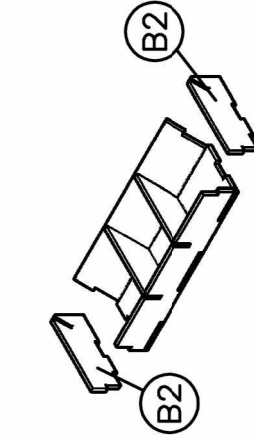
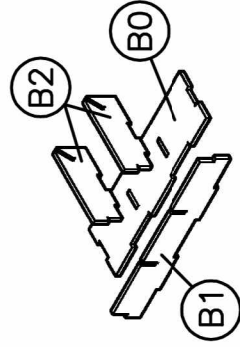

Container Concrete Mixers, Excavators, Water Drops

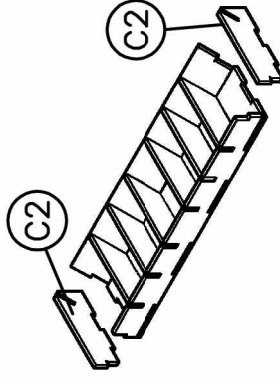
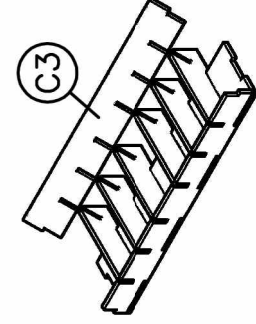
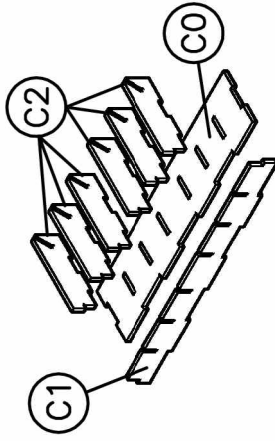

Container for Contract Tiles and Advanced Technology Tiles

Note the indentations in the bottom and sides

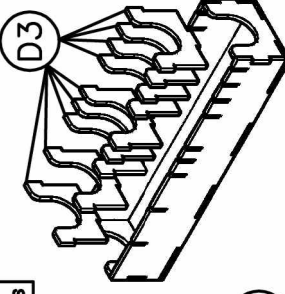
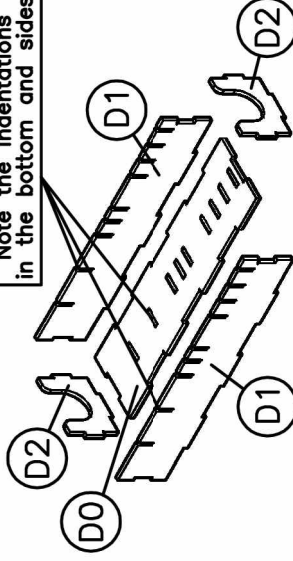

Container for tiles: Headstream, Starting Setup, Private Contract and Executive Officers

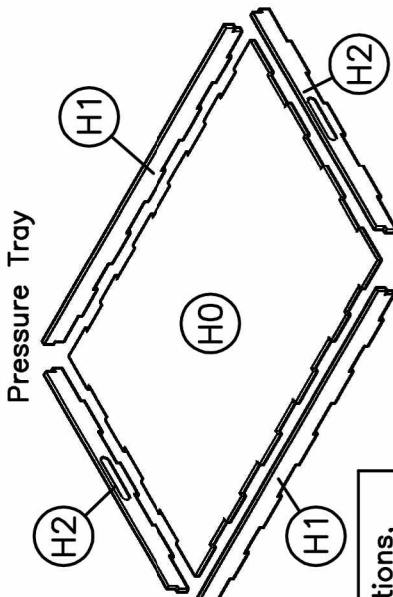
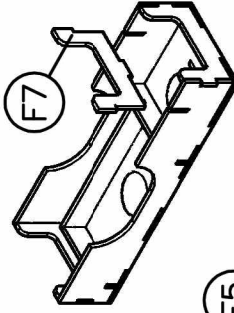
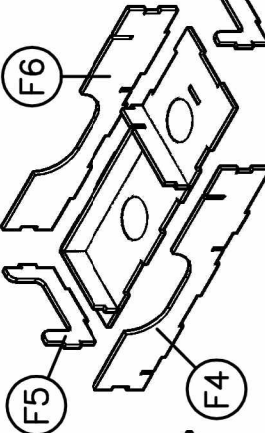
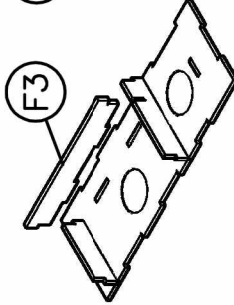
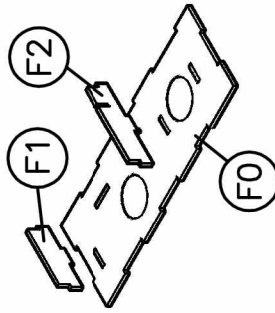

Container for Automa Tiles and Player Aids

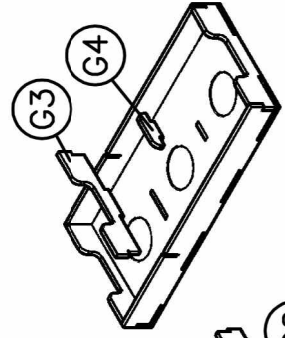
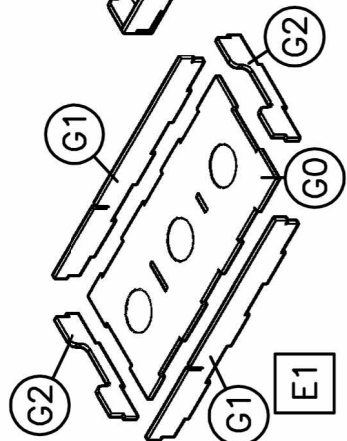

Tray for Objective tiles, Bonus tiles, Neutral Elevations, Neutral Bases and Construction Wheels

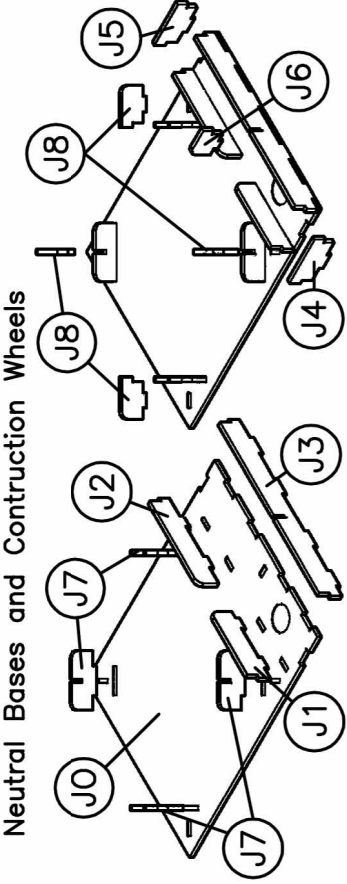

reDrewNO



BARRAGE – TAFLA 1

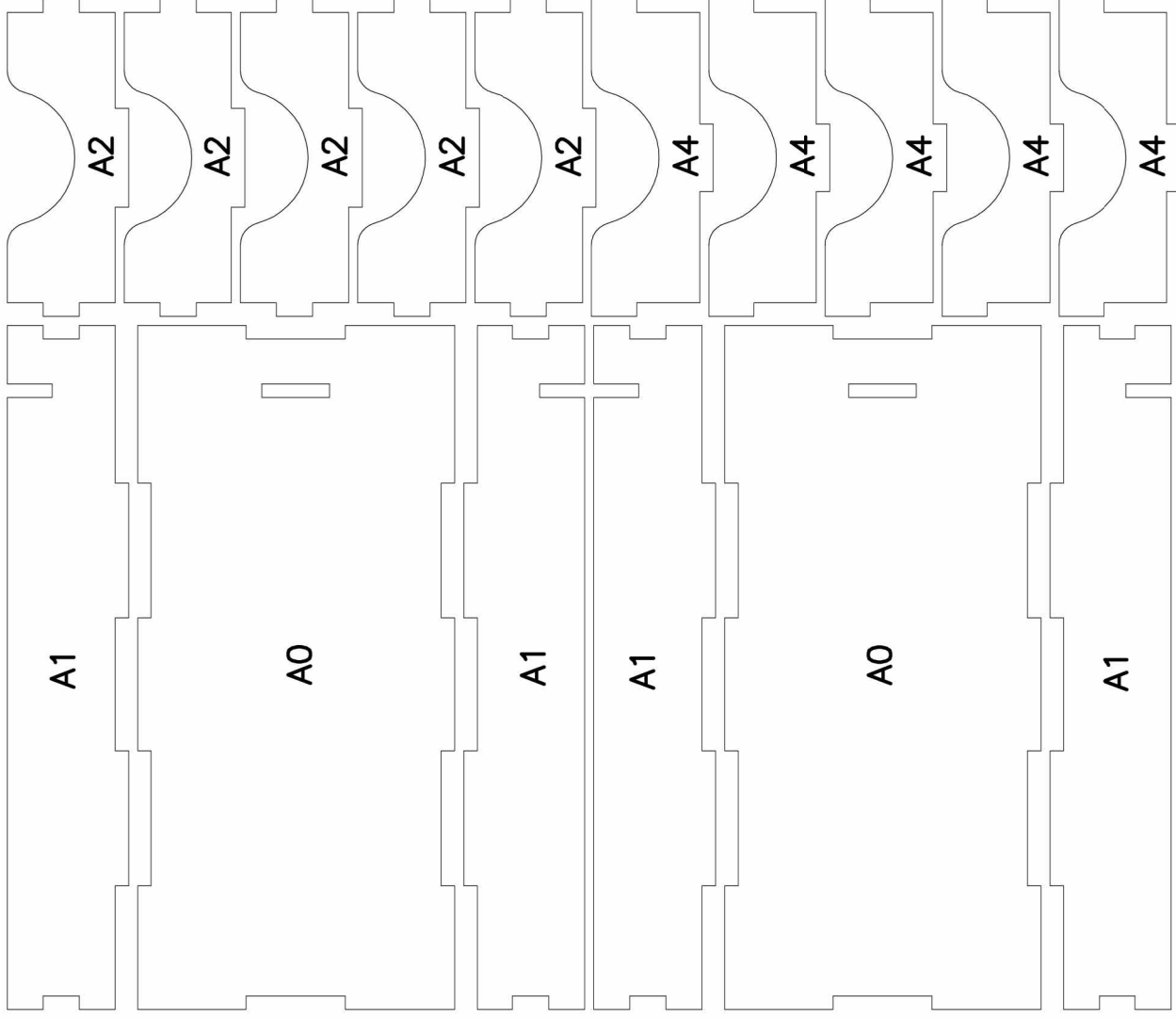

BARRAGE – TAFLA 2

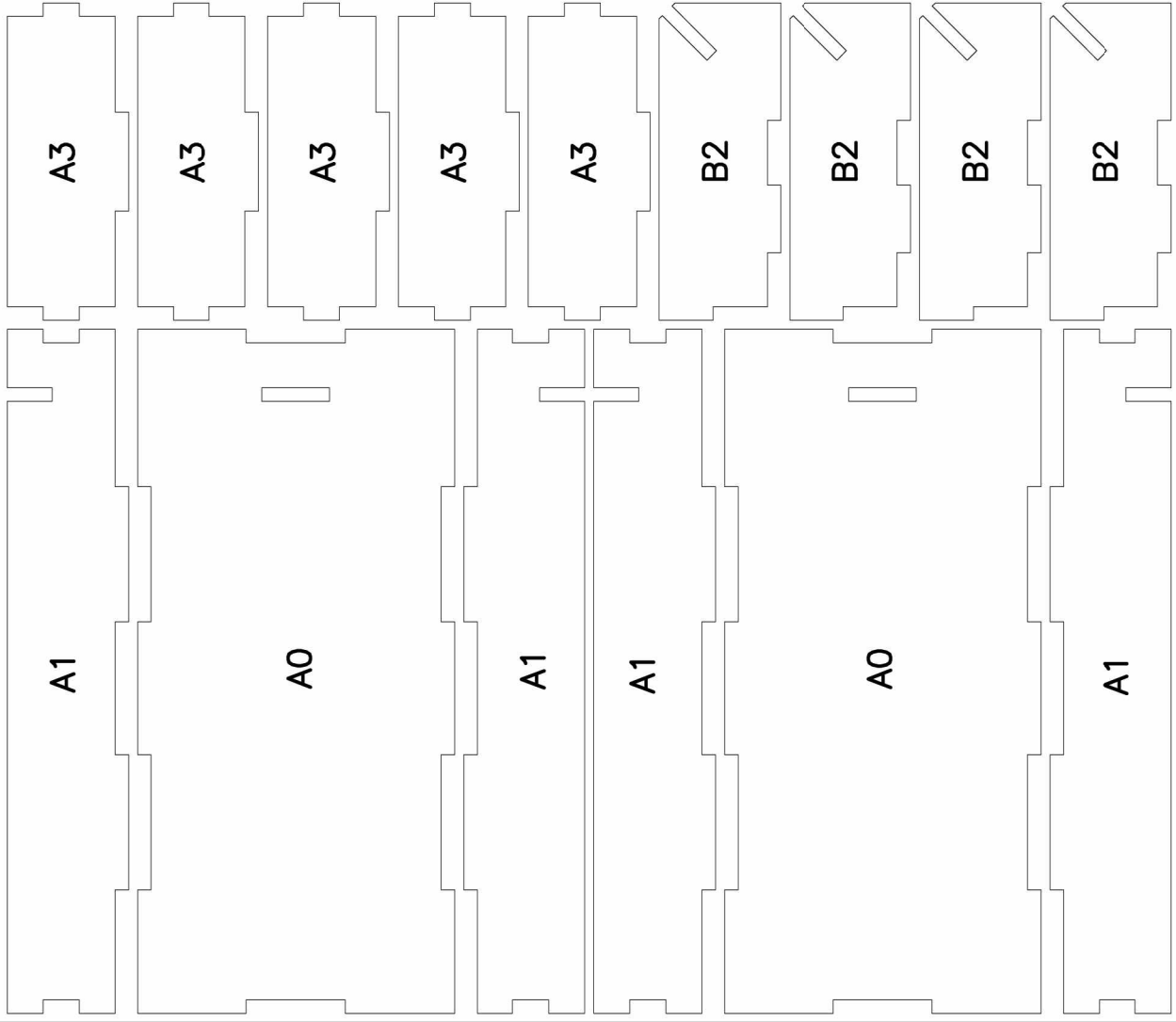

BARRAGE – TAFLA 3

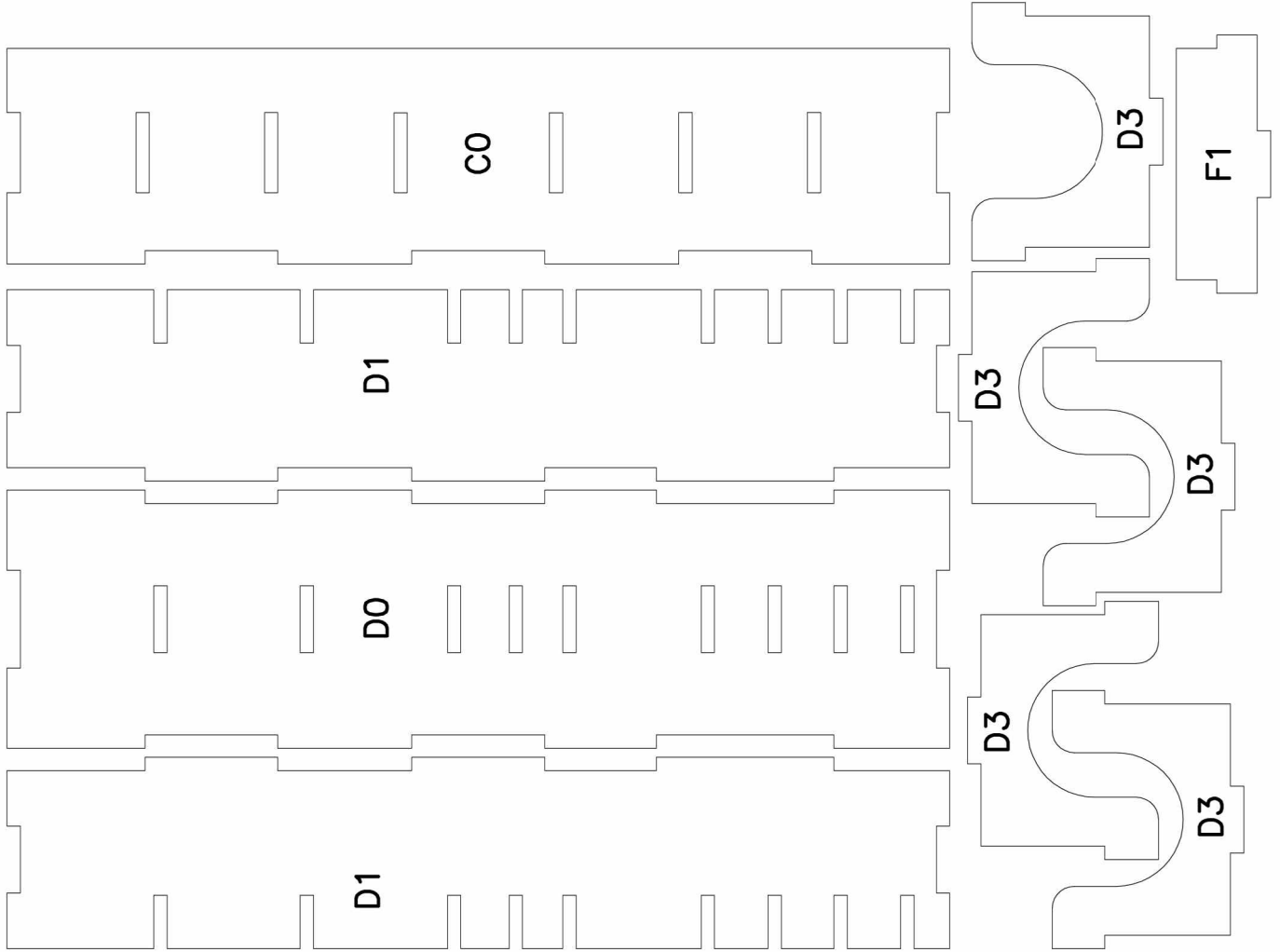

BARRAGE – TAFLA 4

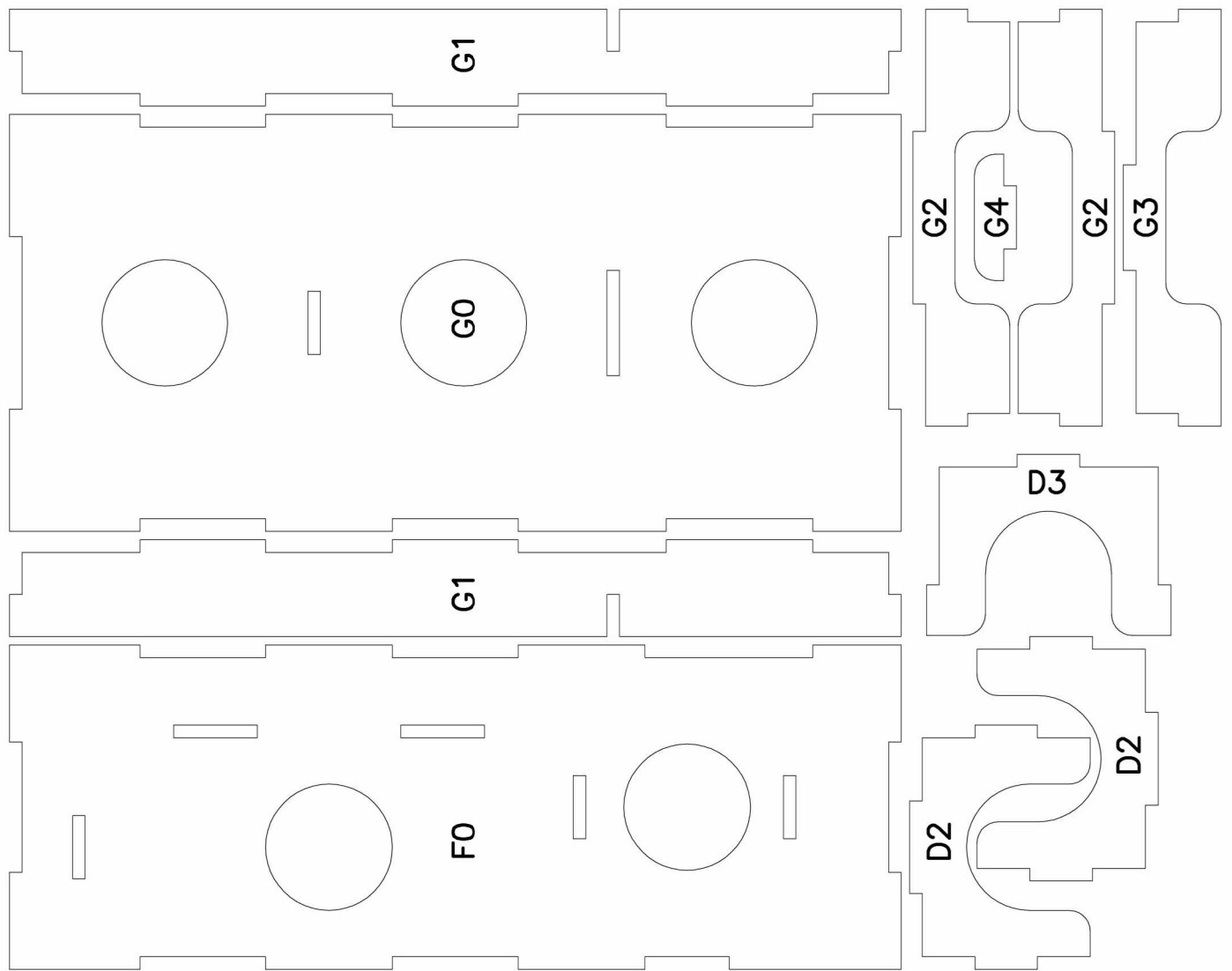

BARRAGE - TAFLA 5

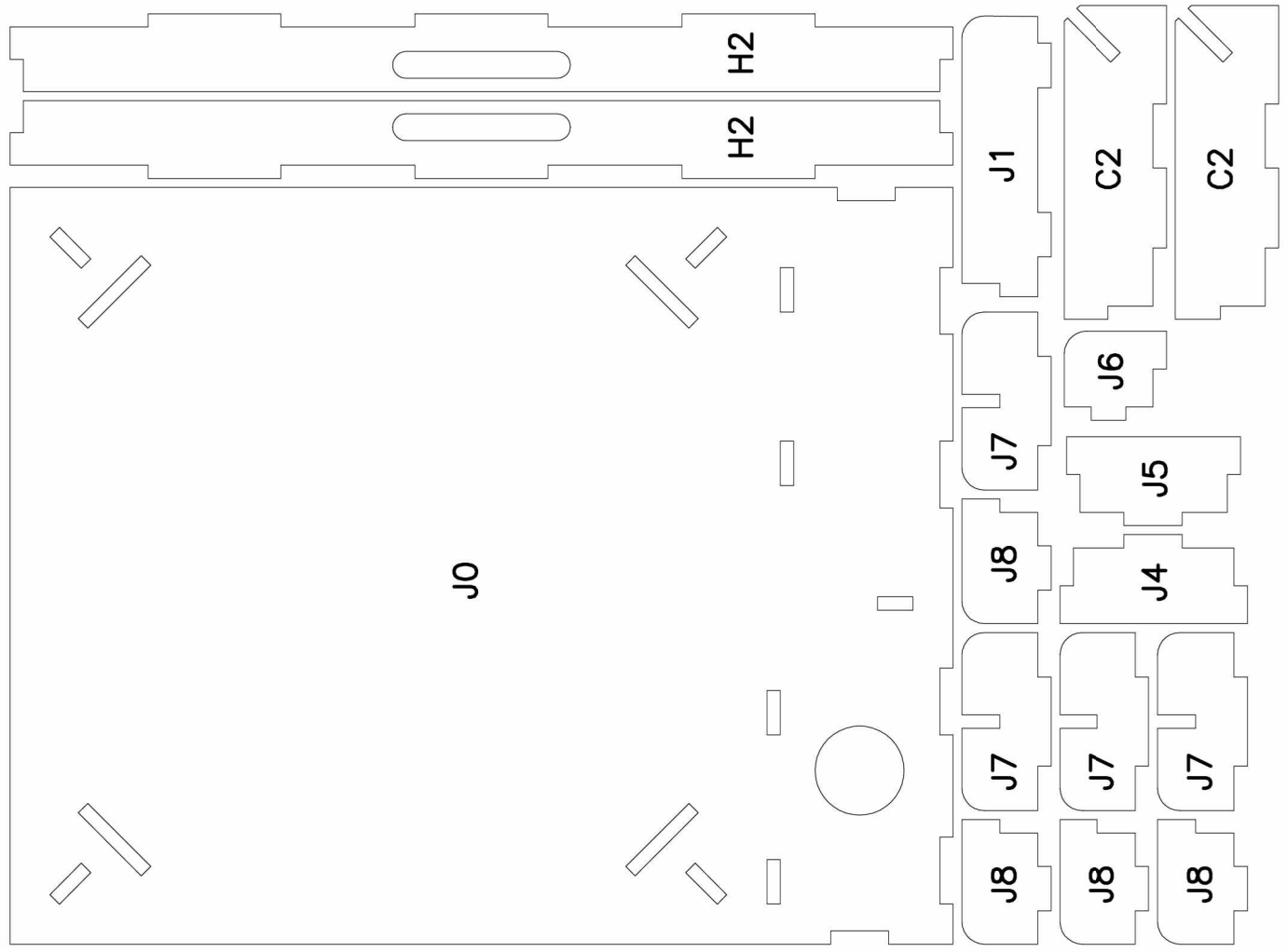

BARRAGE - TAFLA 6

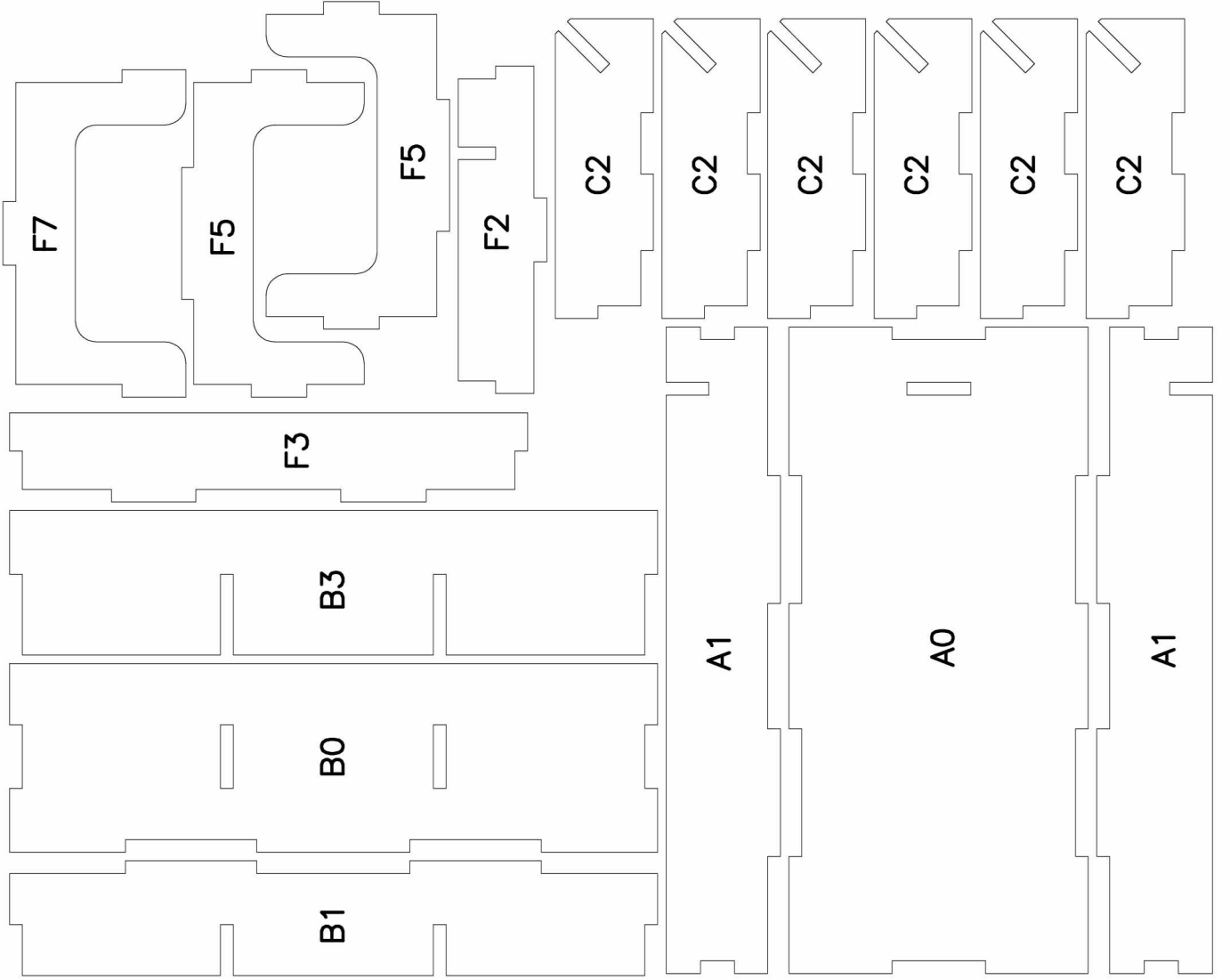

BARRAGE – TAFLA 7



BARRAGE – TAFLA 8

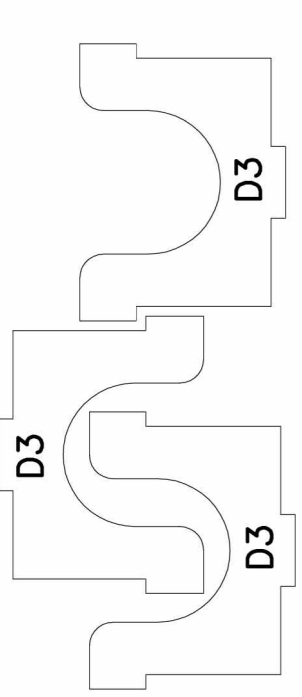
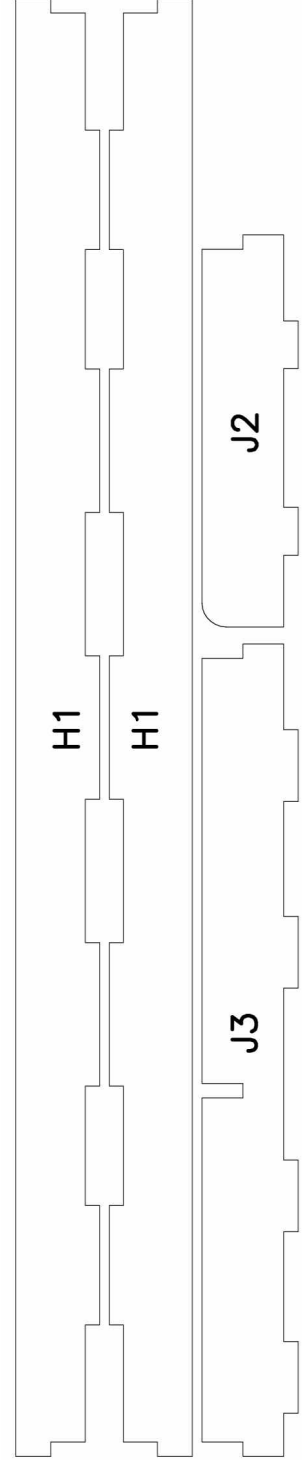
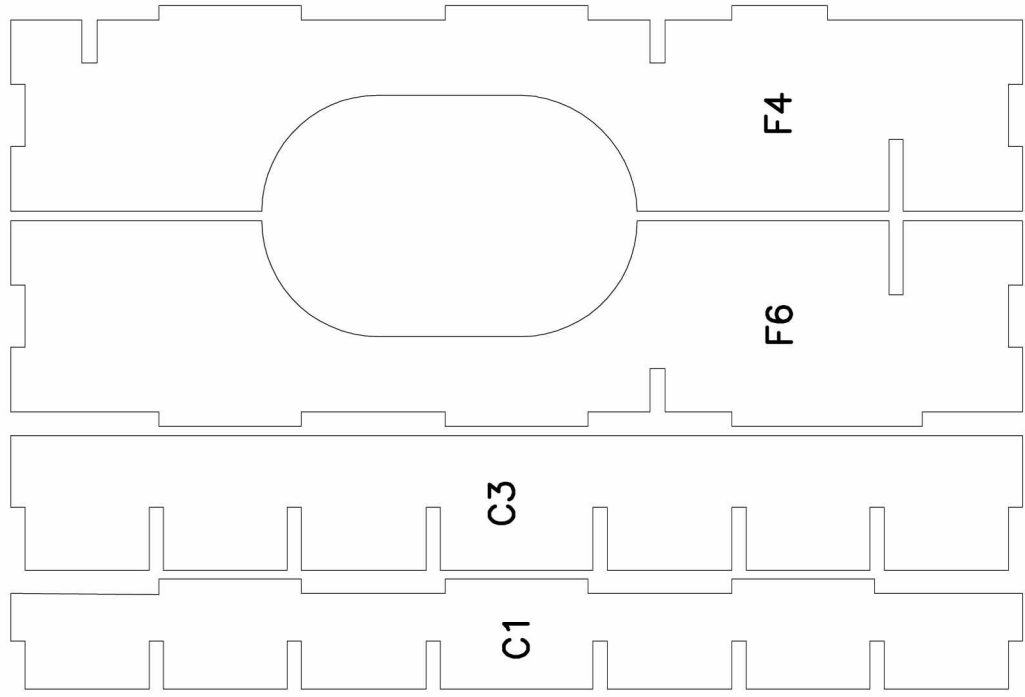

BARRAGE – TAFLA 9