

Manual of proper gluing and set-up of containers in game box for Empires of the North

Crowd out gently elements from the tail – it is recommended to use a paper knife to cut connection points.

Prepare only elements that must be linked together.

Do not cut out all the pieces at the same time as you may stir them and make a mistake.

Some elements are designed in such a way that it is impossible to glue them wrongly. If you have some problems, try to rotate the element – it should help. Be attentive – some pieces differ slightly from each other.

It is recommended to use wood glue.

If you have some doubts or you need help, please contact us by e-mail or our Facebook profile – reDrewno.

Different kinds of containers are marked by letters and numbers.

The order of gluing was shown by lines from left to right and from top to bottom.

After gluing, leave the insert for a minimum of 24 hours until fully dry. Then arrange the elements according to the engravings on the containers and the instructions.

Container for cards

Container for clan tokens

Container for cards

Container for clan tokens

2x Container for markers and clan tokens

Container for cards

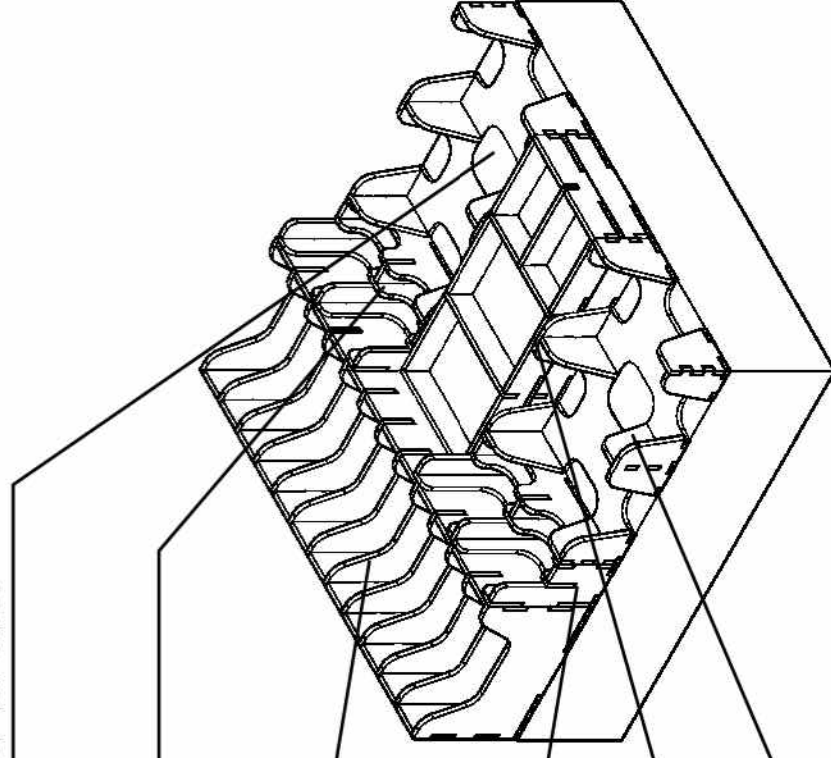

Place the original plastic organizer in the lower part of the insert.
Then put the scoreboard and expedition board on the plastic organizer
Then put the rulebook on top

We invite you to visit our shop and check photos with the elements and arrangement of the insert in the box.

Thank you for buying of our insert.
We wish you only successful games!
reDrewno.pl Shop Team
sklep@redrewno.pl



reDrewno

Container for cards

After gluing, slide in the spacers

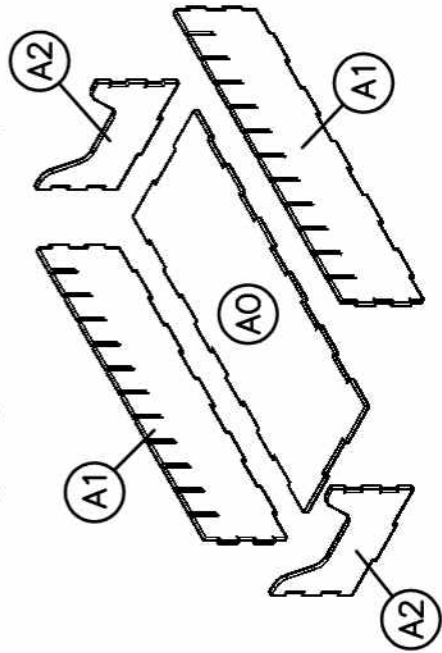

Container for tokens – 1

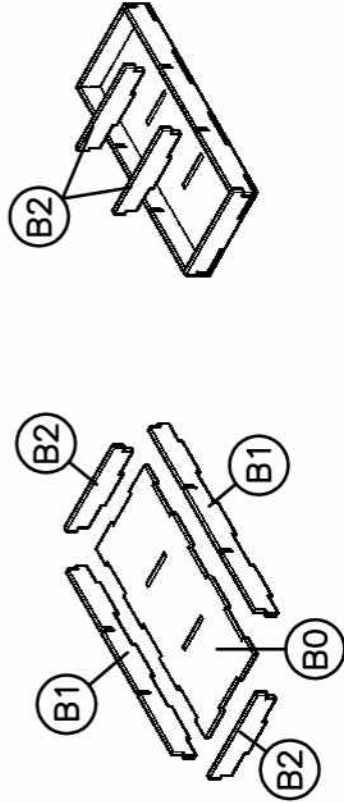

reDrewno

Container for tokens – 2

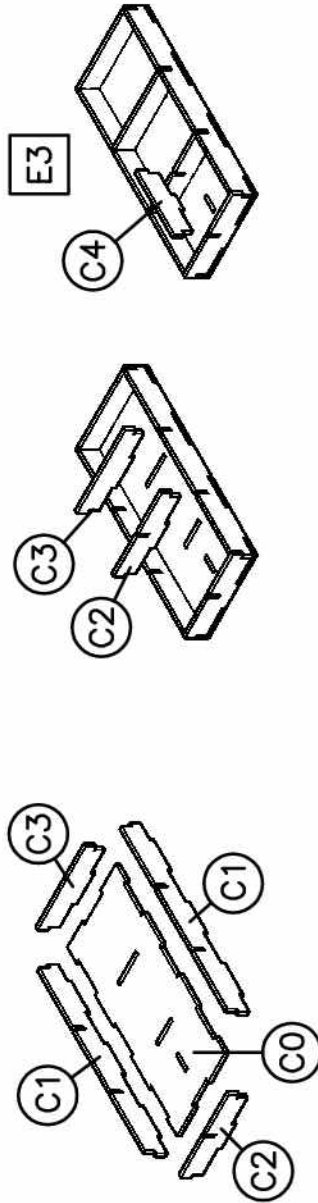

2x Container for cards

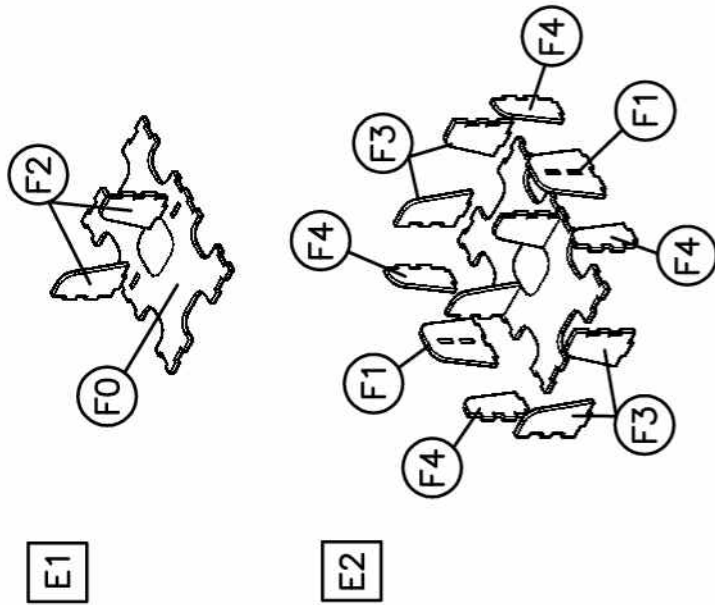

2x Container for tokens – 3

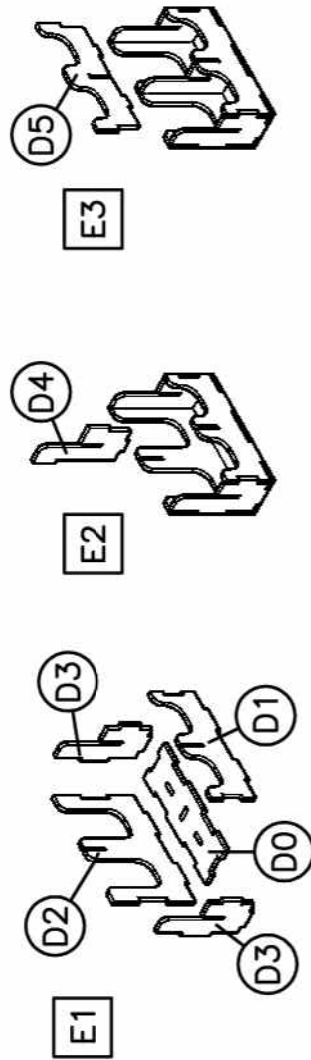

O:KP - TAFLA 2

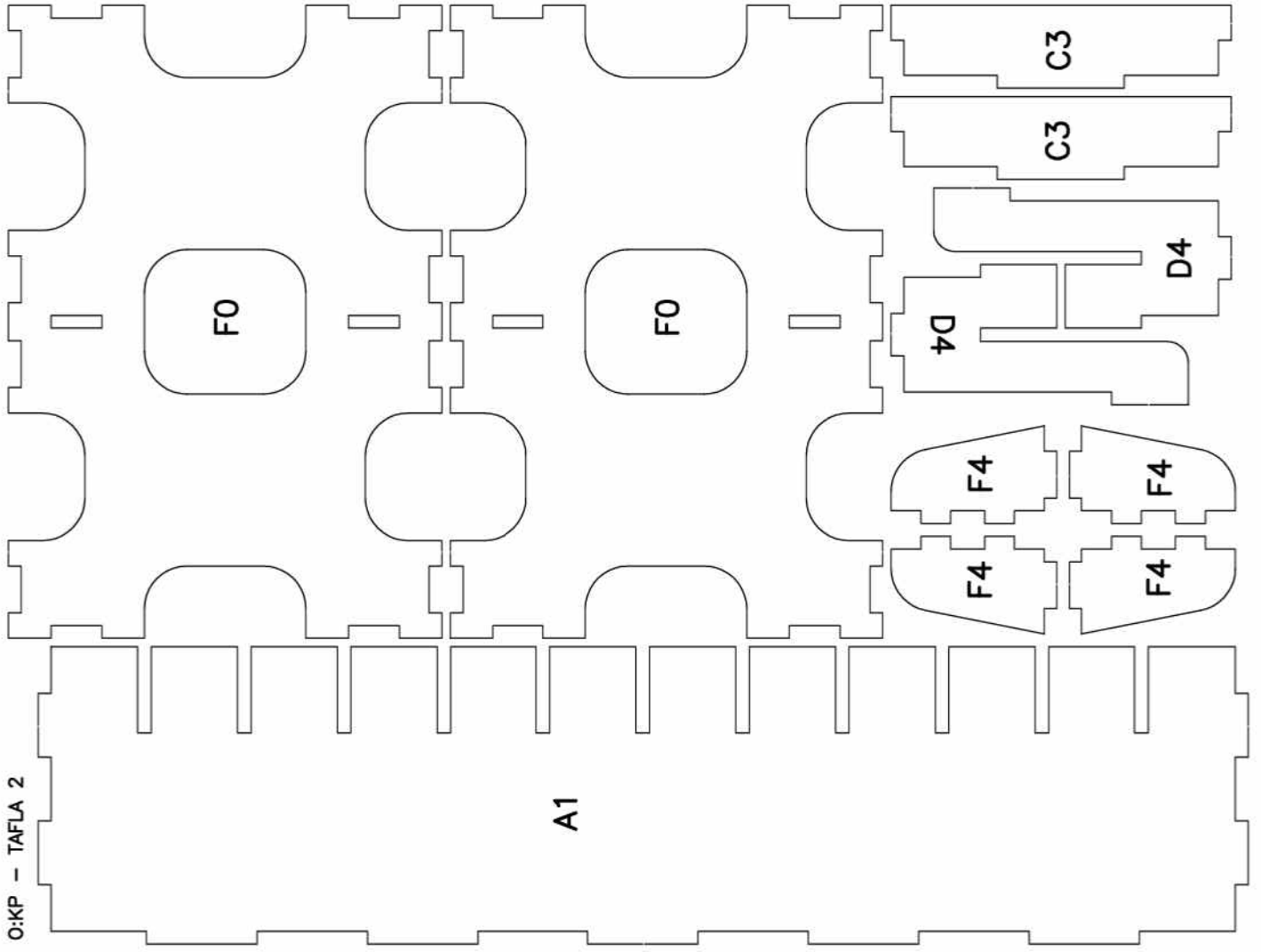

O:KP - TAFLA 1

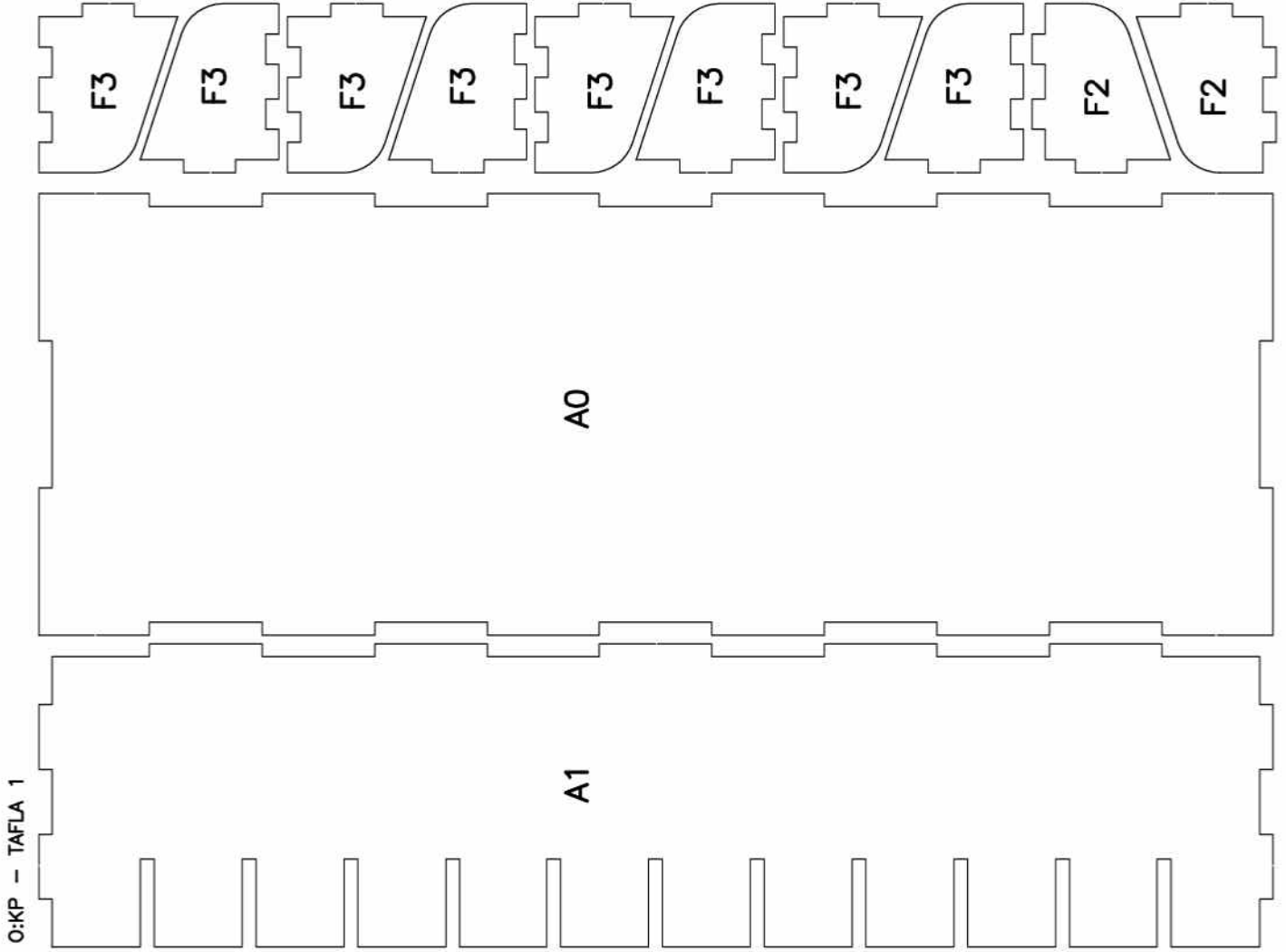

O:KP - TAFLA 3

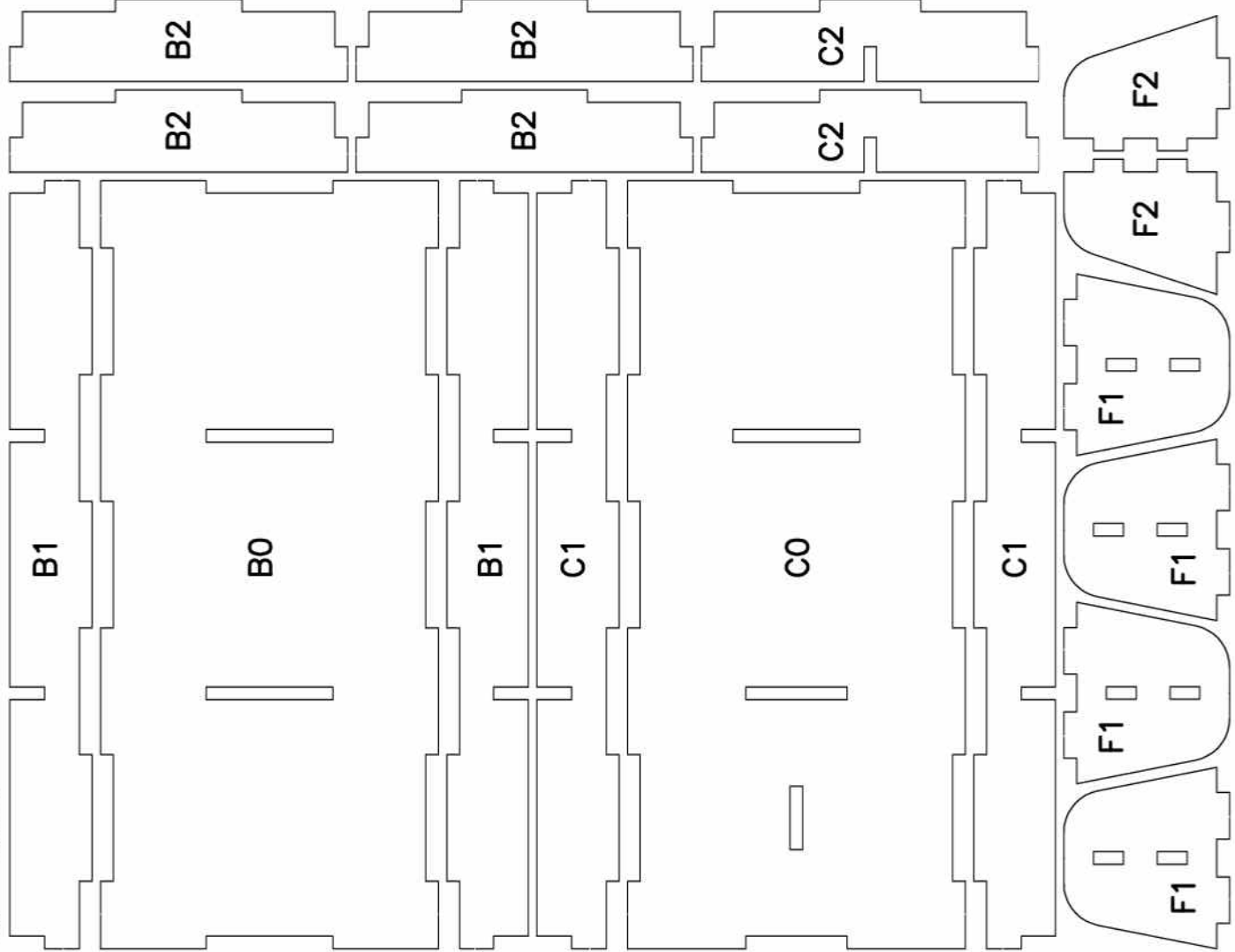

O:KP - TAFLA 4

