

Manual of proper gluing and set-up of containers in game box for Imperial Settlers

Crowd out gently elements from the tail – it is recommended to use a paper knife to cut connection points.

Prepare only elements that must be linked together.

Do not cut out all the pieces at the same time as you may stir them and make a mistake.

Some elements are designed in such a way that it is impossible to glue them wrongly. If you have some problems, try to rotate the element – it should help. Be attentive – some pieces differ slightly from each other.

It is recommended to use wood glue.

If you have some doubts or you need help, please contact us by e-mail or our Facebook profile – reDrewno.

Different kinds of containers are marked by letters and numbers.

The order of gluing was shown by lines from left to right and from top to bottom.

After gluing, leave the insert for a minimum of 24 hours until fully dry. Then arrange the elements according to the engravings on the containers and the instructions.

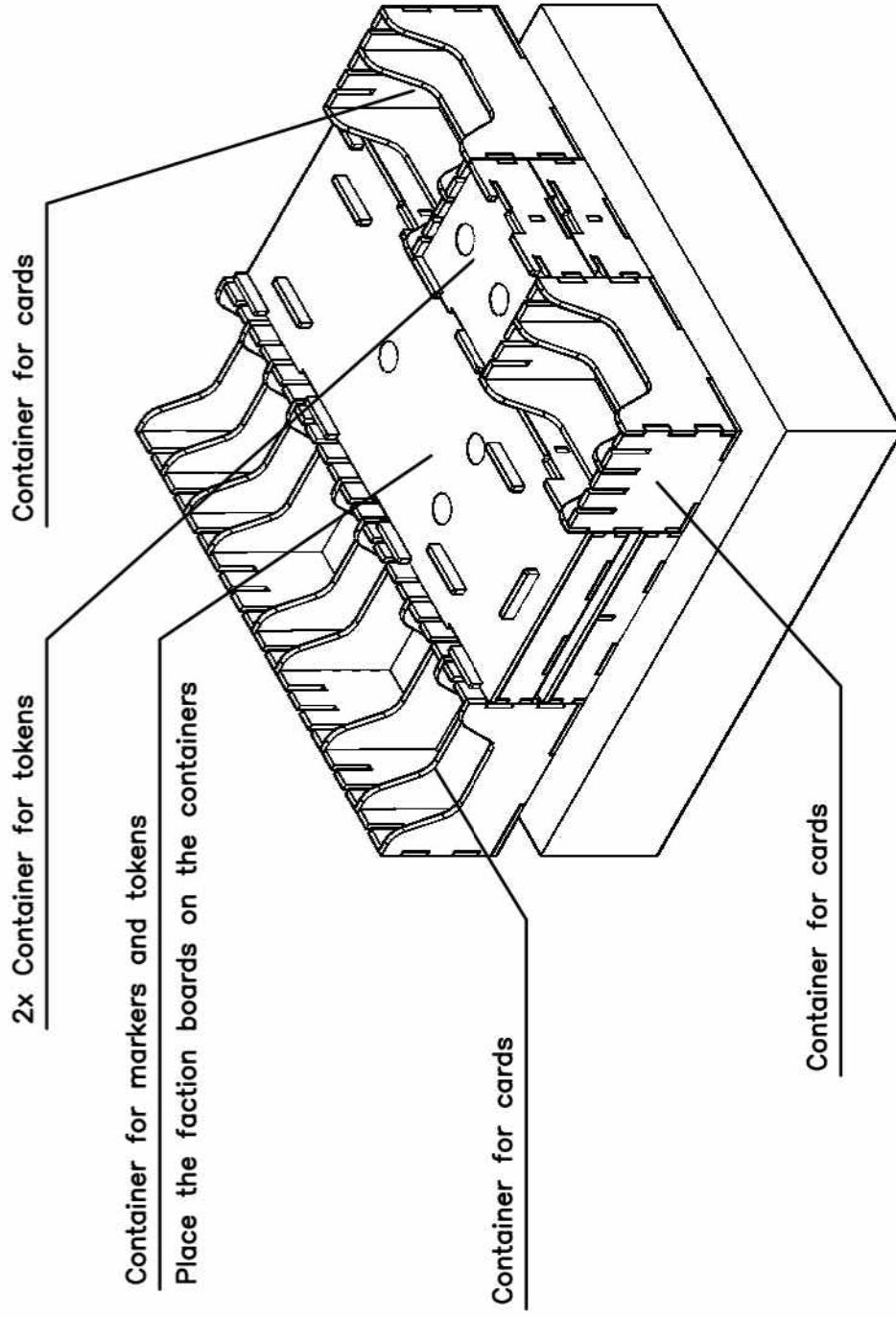

Put the score board and rulebook on top of the insert

We invite you to visit our shop and check photos with the elements and arrangement of the insert in the box.

Thank you for buying of our insert.
We wish you only successful games!
reDrewno.pl Shop Team
sklep@redrewno.pl



reDrewno

Manual of proper gluing of containers – Imperial Settlers

Container for cards

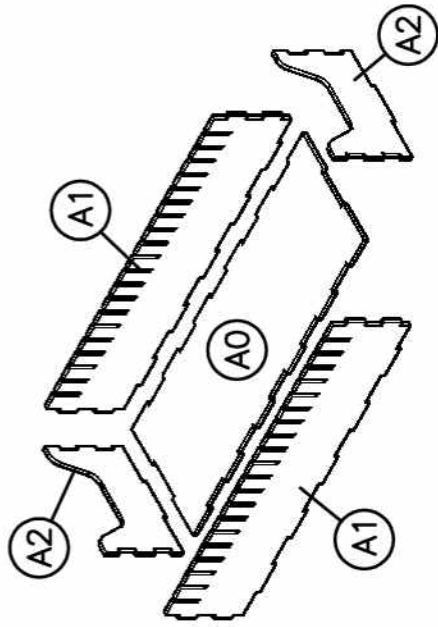

Container for markers and tokens

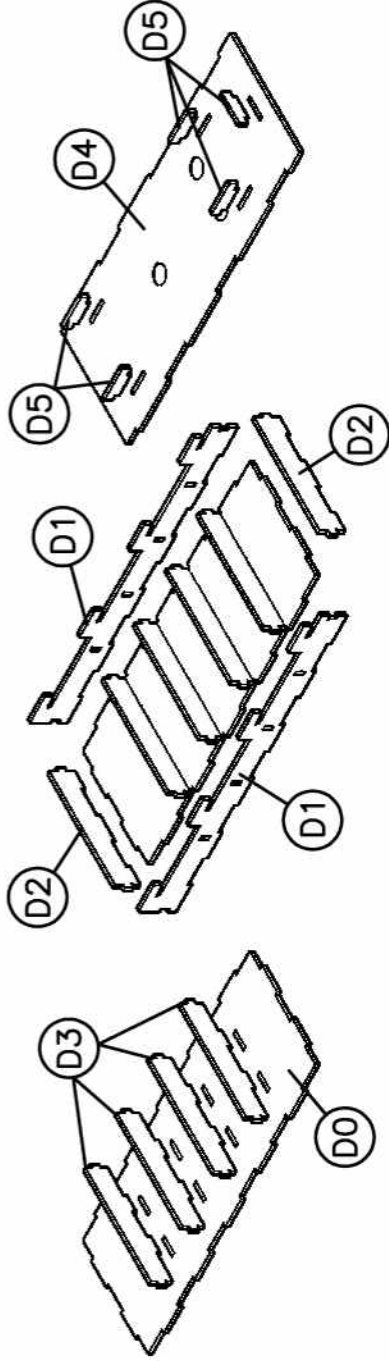

Container for markers and tokens

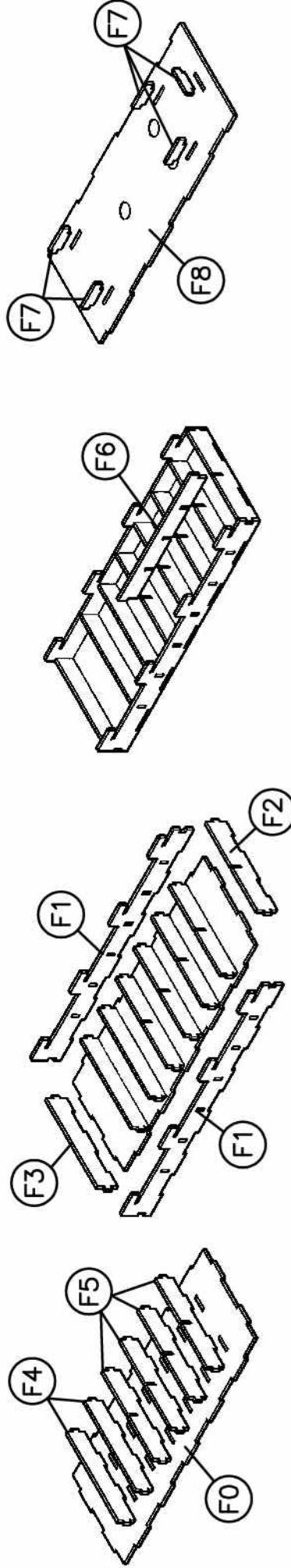

Container for cards – 2x

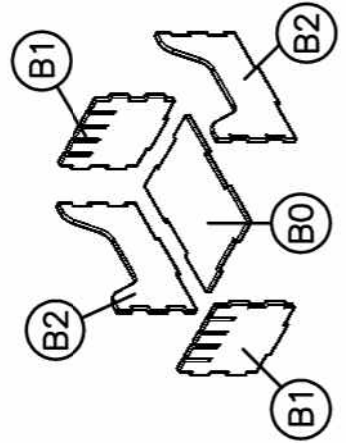

Container for tokens – 2x

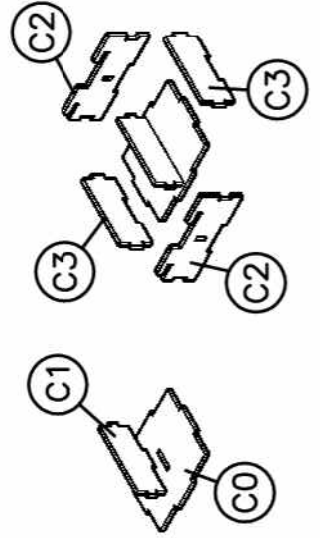

After gluing on the C / D / F containers,
close with the C4 / D4 / F8 locks

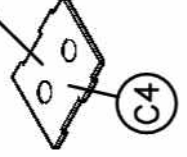

reDrewno

O:NI - TAFLA 2

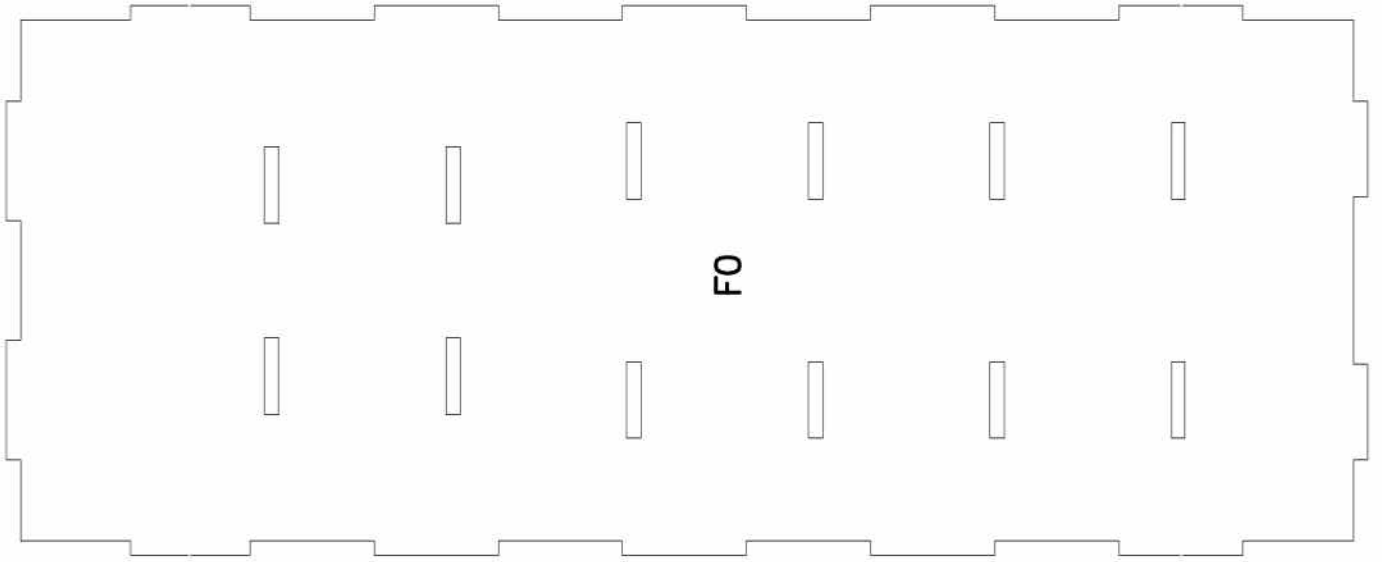

F0

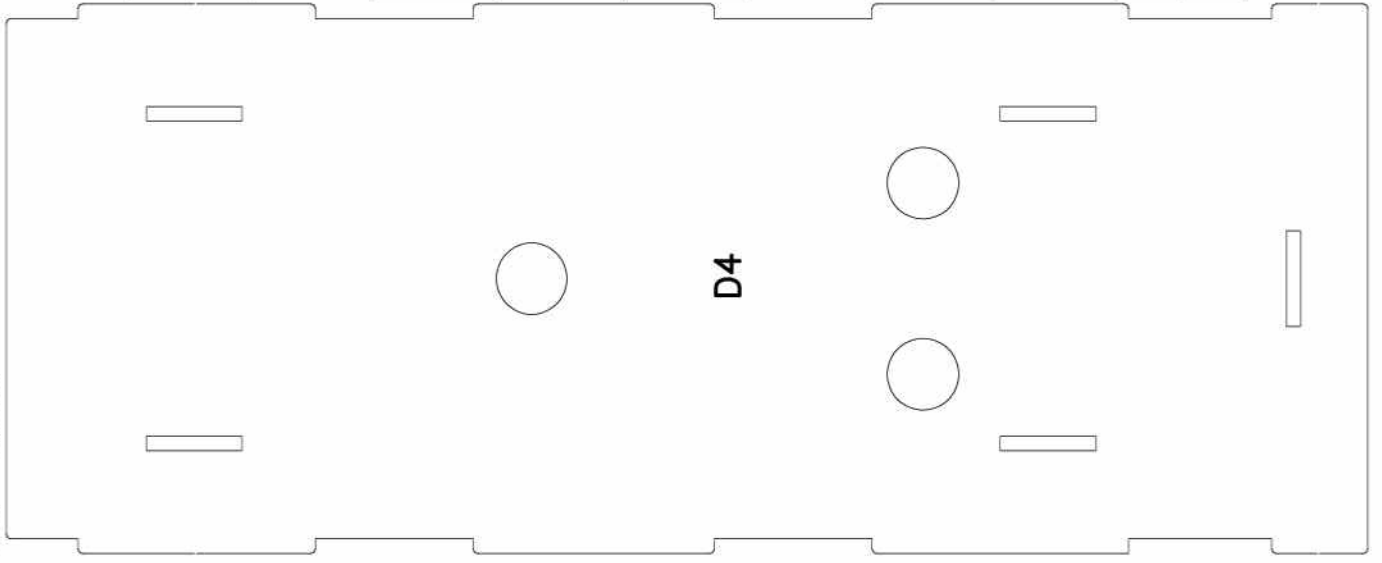

D4

O:NI - TAFLA 1

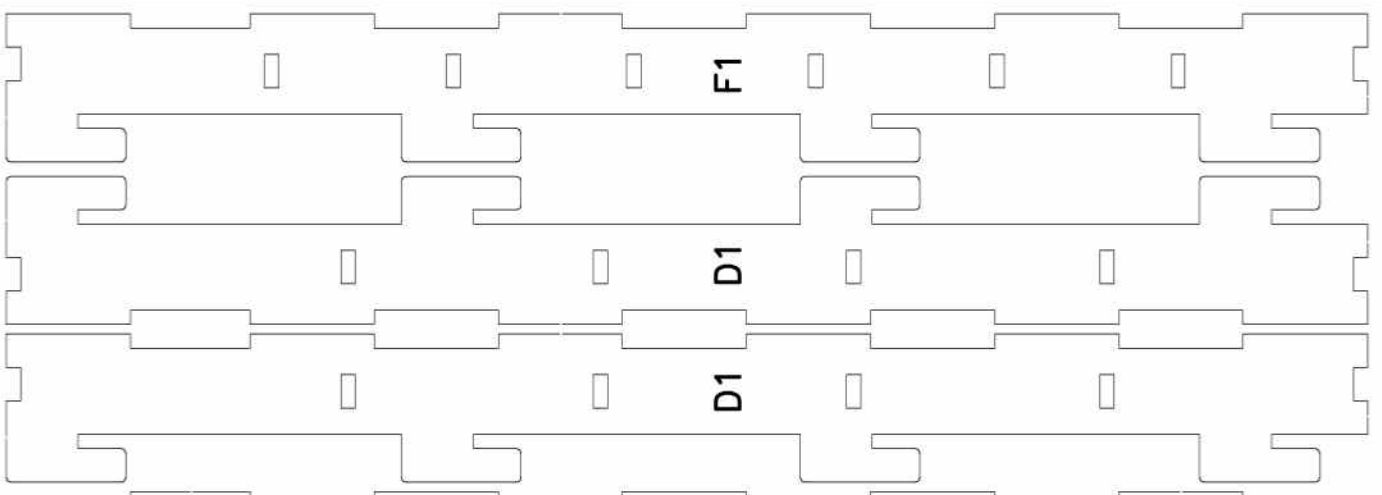

F1

D1

D1

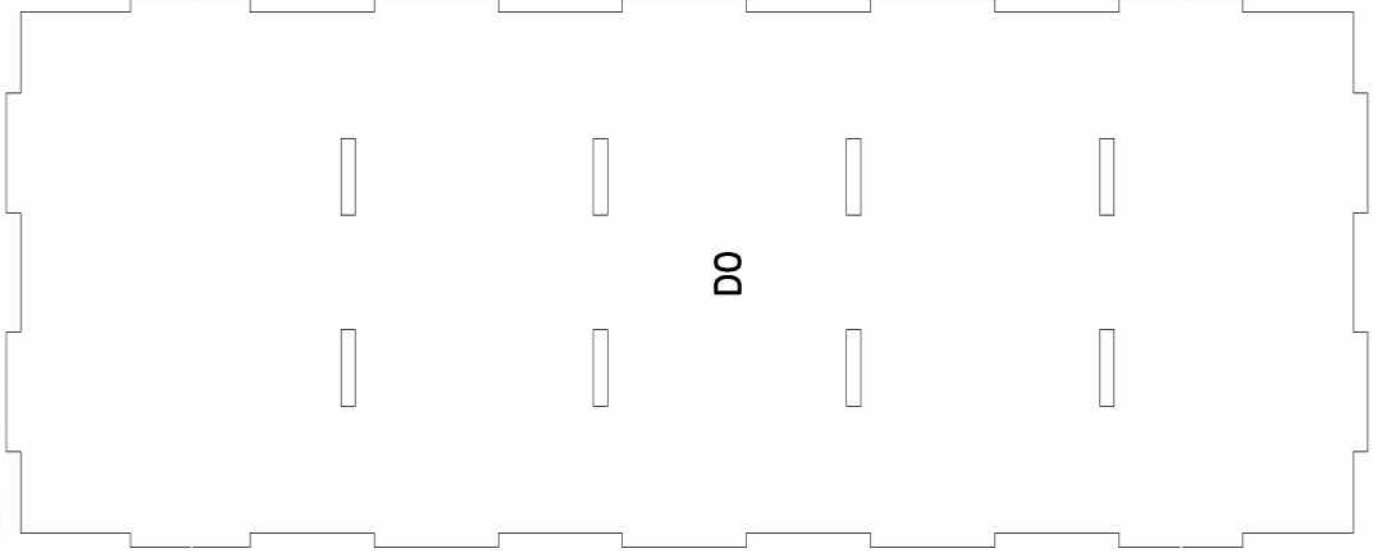

D0

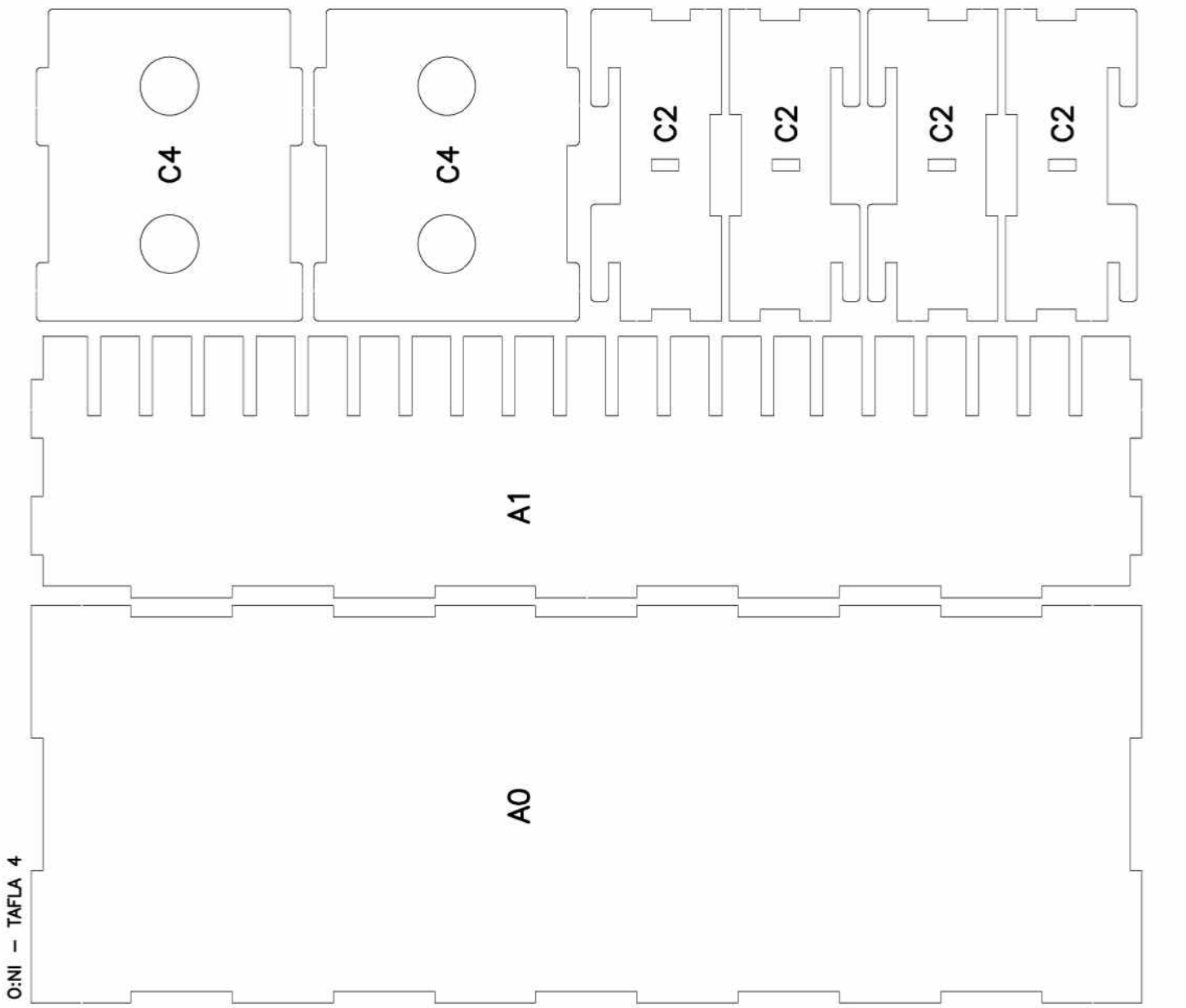
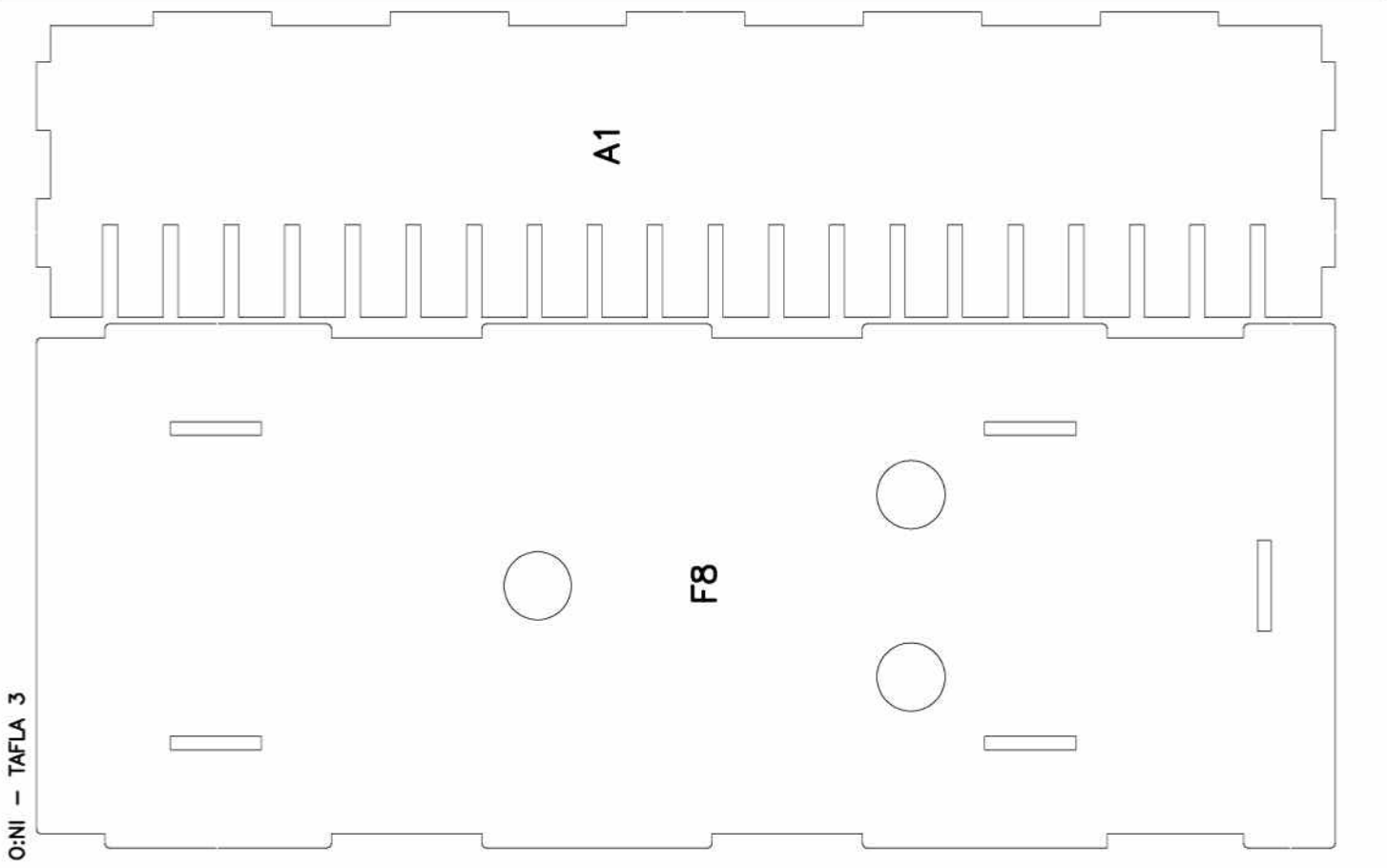

O:NI - TAFLA 5

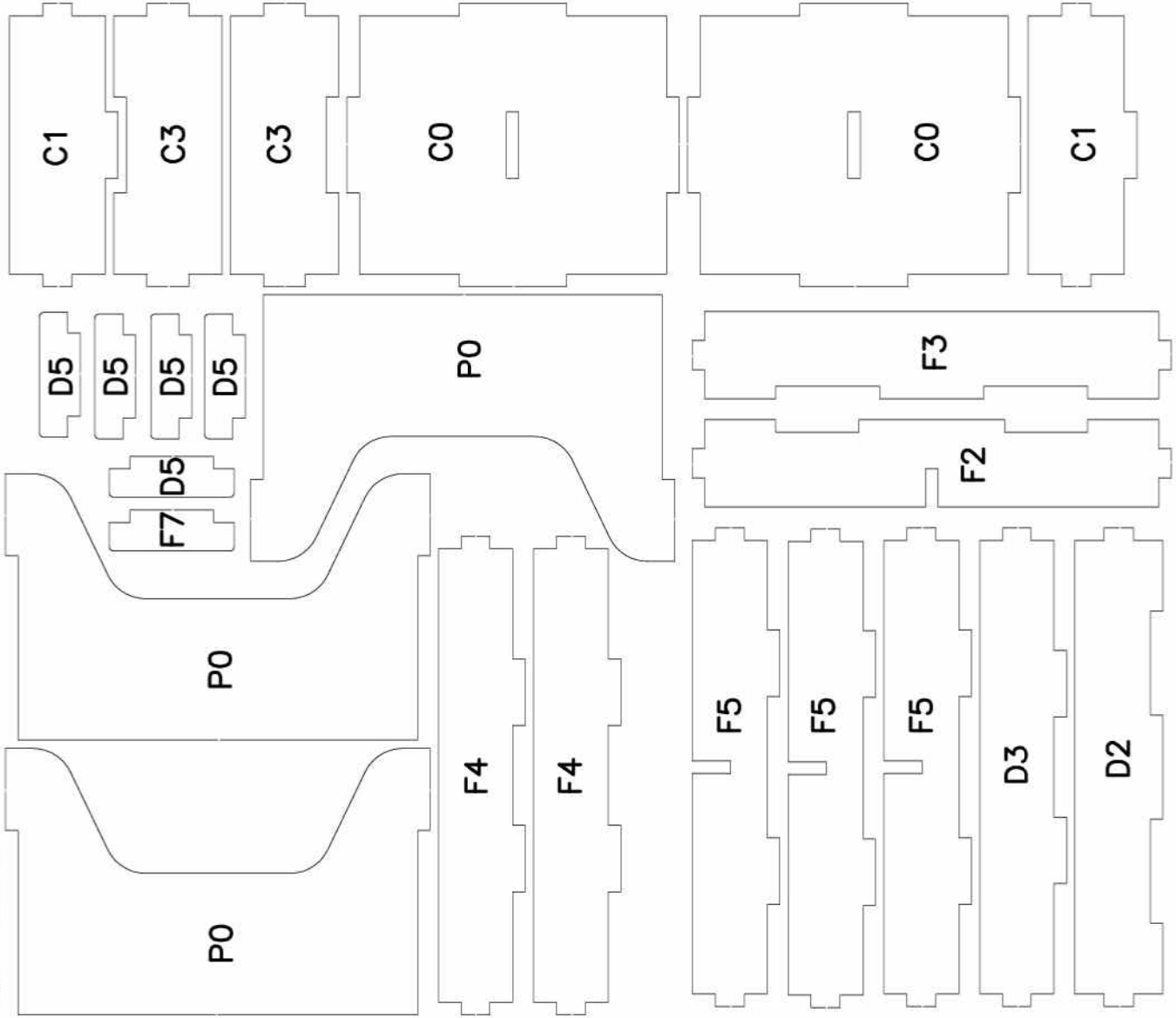

O:NI - TAFLA 6

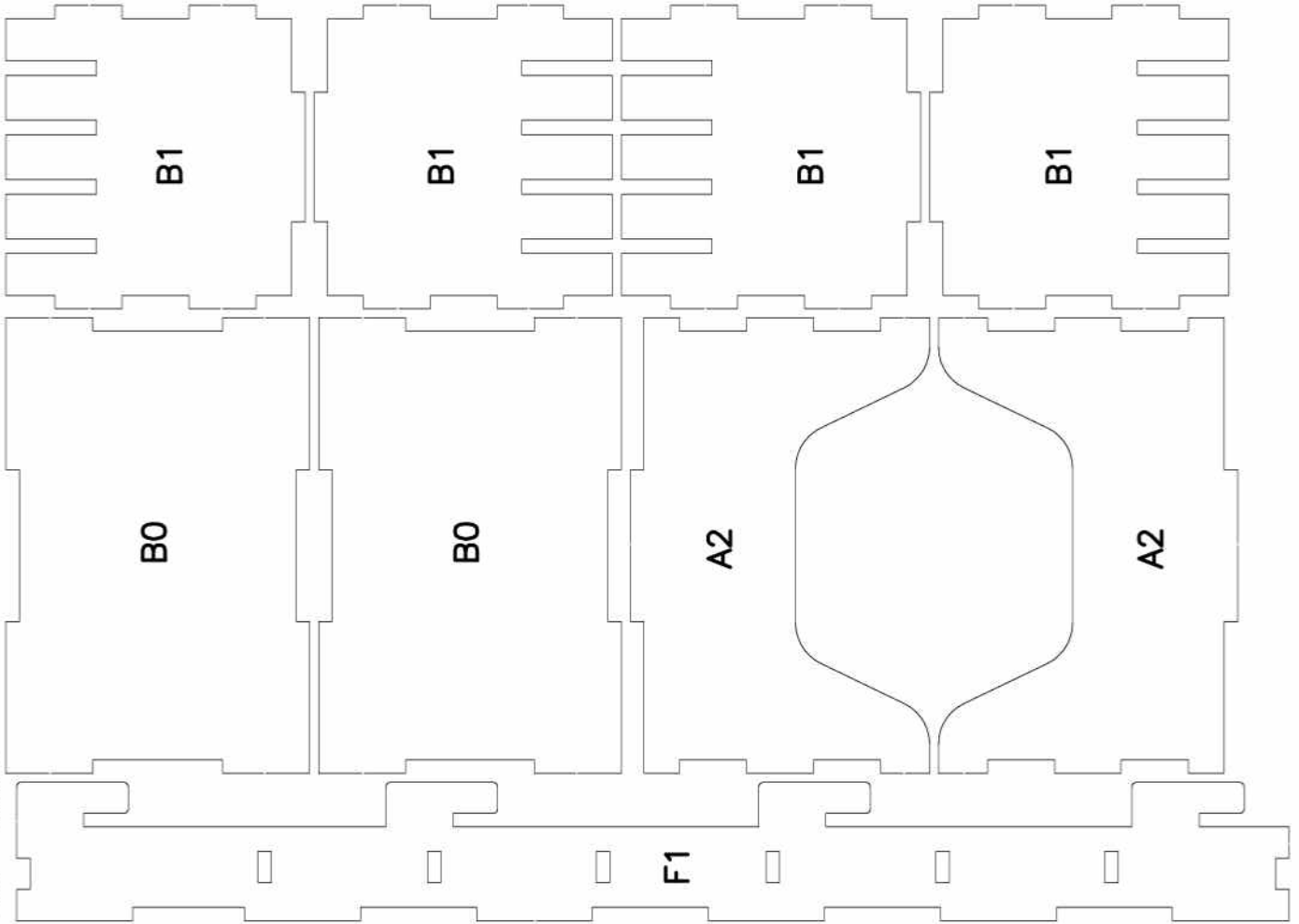

O:NI - TAFLA 7

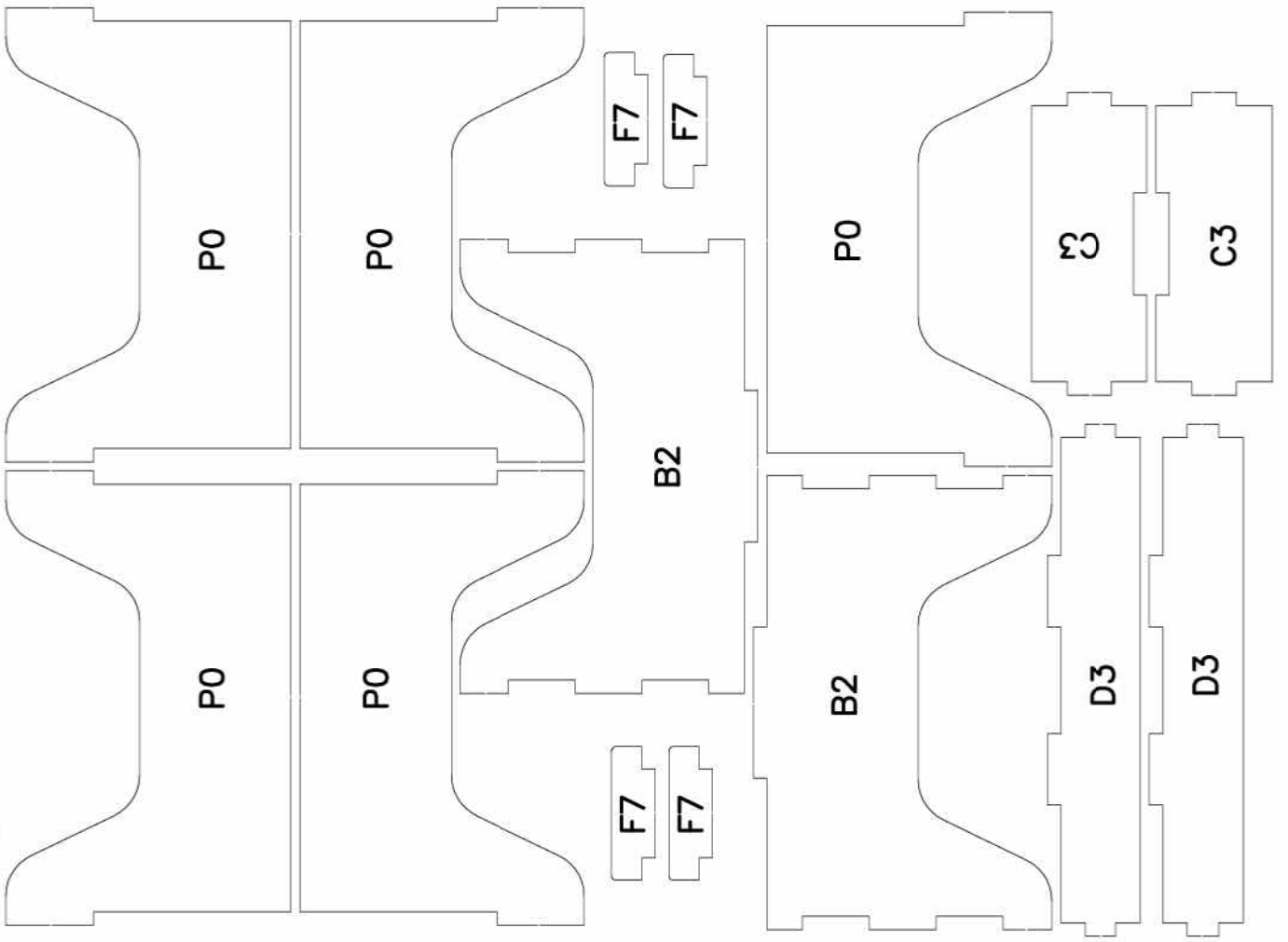

O:NI - TAFLA 8

